

STAINLESS STEEL NEEDLE VALVES NV400

DESCRIPTION

The NV400 is a series of high pressure needle valves designed for shut-off applications with steam and other industrial fluids.
 The NV400B is a special version designed for use as a boiler water sample valve when connected to the bottom sample connection on a VPC TDS blowdown control valve.

MAIN FEATURES

Complete stainless steel construction.
 High quality graphite packing.

OPTIONS: Version for oxygen service.

USE: Saturated steam, water, compressed air and other fluids compatible with the construction.

AVAILABLE MODELS: NV400H; NV400B.

SIZES: 1/4" to 1/2".

CONNECTIONS: NV400H – Female threaded ISO 228.
 NV400B – Inlet: Female threaded ISO 228.
 Outlet: Comp. fitting 8S (M16 x 1,5).

INSTALLATION: In any position.

Remarks:
 Other sizes, materials and connections available on request.



NV400H



NV400B

BODY LIMITING CONDITIONS

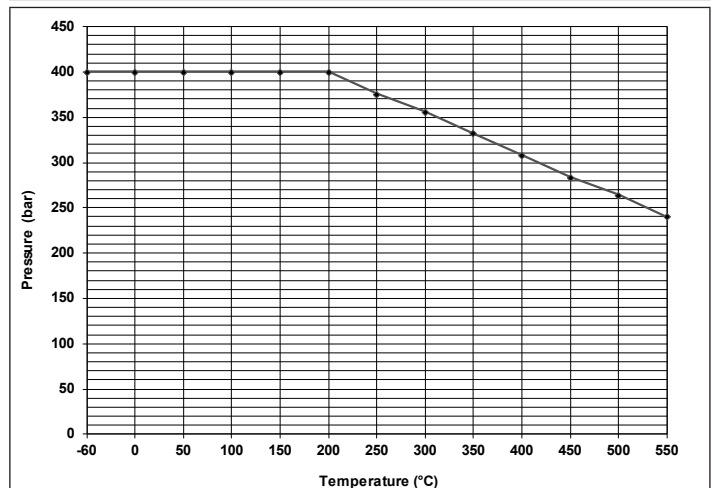

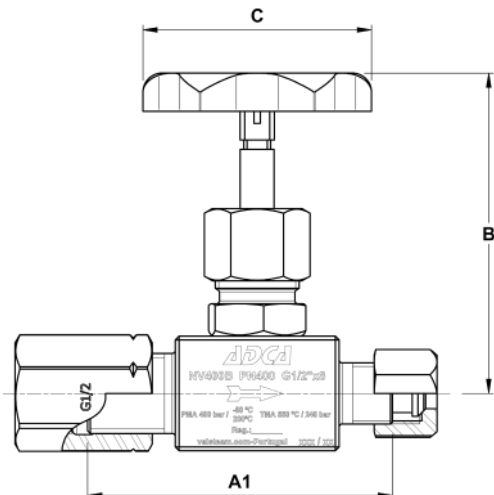
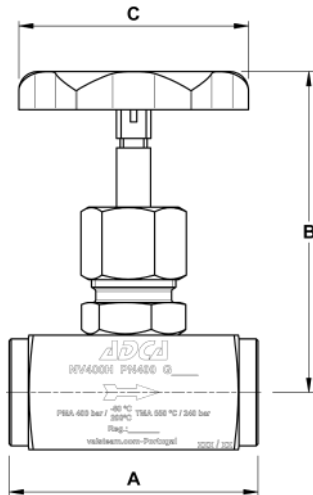

DIMENSIONS (mm) – NV400H

SIZE	A	B	C	ORIFICE	WEIGHT (kg)
1/4"	55	82	70	6	0,48
3/8"	60	82	70	6	0,49
1/2"	65	82	70	6	0,49

DIMENSIONS (mm) – NV400B

SIZE	A1	B	C	ORIFICE	WEIGHT (kg)
1/2"	80	82	70	6	0,63

FLOW RATE COEFFICIENTS (m³/h)

	SIZES		
	1/4"	3/4"	1/2"
Kvs	0,56		

For conversion Kvs = Cv (US) x 0,855.

MATERIALS

POS.	DESIGNATION	MATERIAL
1	Body	AISI 316 Ti / 1.4571
2	Bonnet	AISI 316 Ti / 1.4571
3	Stem	AISI 316 Ti / 1.4571
4	Packing nut	AISI 316 Ti / 1.4571
5	Packing gland	AISI 316 Ti / 1.4571
6	Packing	Graphite
7	Handwheel	Metallic
8	Compression fitting	AISI 316 Ti / 1.4571
9	Alignment union	AISI 316 Ti / 1.4571

